



NEMA 1 • Outdoor 3R • Walk-In

**ADVANCED POWER
TECHNOLOGIES**

**2.4kV – 15kV
Compact ATS
Vacuum Circuit Breaker
Automatic Transfer Switchgear**



**APTView
Enabled**

**MED-Series ATS
Beyond Legacy Metal Enclosed Switchgear**

Solutions Brochure



www.appt-power.com



1501 Veterans Memorial Pkwy E
Lafayette, IN 47905



(765) 446-2343



Volume Production

Advanced Engineered Solutions



ALN: 540-AT Rev. 04

Solution Brochure Contents

Applications – Why MED-ATS Switchgear?	3	Installation Drawings: MED-15-3R-BB-VW	18
NextGen ATS Architecture & Ratings	4	Installation Drawings: MED-15-1S-TT-VF	19
Automatic & Manual Transfer Controls.....	5	Installation Drawings: MED-15-3R-BB-VF	20
Advanced SCADA Controls - APTView	6	Protective Relaying Functions.....	21
Utility & Generator Sections.....	7	Lockout Relays & Test Switches	22
Tie, Distribution, Control Power Sections	8	Power Sensing & Revenue Grade Metering	23
Withdrawable Vacuum Circuit Breakers (VCBs) ...	9	Switchgear Surge Arresters	24
Modern Simplicity Meets Proven Reliability	10	Surge Capacitors and RC Snubbers.....	25
Withdrawable Cell & VCB Removal.....	11	Outdoor Walk-In Switchgear Enclosures	26
Fixed Mount Breaker Option.....	12	APT PwrHouse – Walk-In Enclosure	27
Vacuum Interrupters & Cable Connections	13	APT PwrContainer – ISO Container Switchgear ..	28
Innovative 15kV Main Bus	14	Optional Walk-In Enclosure Features	29
Phase Barriers/Bus Segregation/Insulation	15	Application One-Line Diagrams.....	30
Instrument Transformers – PTs, CTs	16	About Advanced Power Technologies.....	31
Flexible Voltage Sensing Drawers.....	17		



Figure 1*

Applications – Why MED-ATS Switchgear?

Rapid Response

Engineered to deploy fast when every second counts.



Engineered-to-Order

Tailored engineering solutions no off-the-shelf compromises.



Built for Tomorrow

Smaller, Smarter, Future-ready.



Mobile Power Solutions

Reliable power that moves you-anytime, anywhere



Figure 2*



Next-Generation Switchgear Technology for Use In



Data Centers

- Medium Voltage (MV) Switchgear
- Low Voltage (LV) Switchgear
- Automatic Transfer & Distribution
- Engineered Control Power Cabinets



Utilities & Prime Power

- Electric Supply Substations
- Electric Substation Backup
- Water & Wastewater Treatment Plants
- LNG, Trash & Recycling Plants



Manufacturing & Industrial

- Textile
- Steel Mills
- Stamping



Generators & Backup Power

- LV & MV Quick Connections Solutions
- Permanent Gen Protection
- Permanent or Temporary Load Bank
- Temporary Generator
- Manual or Automatic Transfer
- Extended Generator Terminal Boxes



University & Medical Campuses

- Hospitals/Critical Care Centers
- Medical Clinics
- Airports, Train Stations



Mining, Oil Field Drilling, & Fracking

- Vibration Withstand
- Integrated Transformers
- Automatic Paralleling & Transfer
- Integrated Power & Controls



Renewable Energy Collection Control

- Solar, Wind, Geothermal, Biogas, Hydro
- Micro Grids & Reactors
- Energy Storage
- Education, Healthcare, & Transit



Government

- Federal, State, & Local Buildings
- Correctional Facilities
- U.S. Army & Navy Bases

NextGen ATS Architecture & Ratings

APT's Next-Generation Medium Voltage Switchgear Platform Architecture Replaces Traditional Metal-Clad



Figure 3*



Figure 4*

Compact Metal Enclosed Vacuum Circuit Breaker ATS for Tomorrow's Critical Infrastructure

Next-Generation Construction Advantages

Smallest Compact Withdrawable Footprint on the Market: 30% to 70% smaller footprint (depending on arrangement), compared to legacy metal-clad switchgear. 26" wide by 36" deep single high circuit breaker sections available.

Advanced Vacuum Circuit Breakers: New Ultra Compact Withdrawable vacuum breakers with fast fault clearing and minimal maintenance.

Enhanced Reliability & Safety: Reduced complexity, simplified maintenance, enhanced safety features.

Rapid Deployment: Flexible construction options simplify and accelerate installation.

Standard Compact Ratings

Specification	Ratings & Options
Voltage Ratings	2.4 kV – 15 kV
Interrupting Capacity	25 kA, 31.5 kA
Main Bus Ampacity	600 - 4000 A
Bus Insulation Options	Standard: Bare Optional: Insulated
Operation Modes	Manual Automatic Open Transition, Automatic Closed Transition, Delayed, Soft Loading, Parallel
Transfer/Control Configurations	Utility-to-Generator, Utility-to-Utility, Generator-to-Generator, 3-Way
Circuit Disconnect Types	Withdrawable Vacuum Circuit Breakers, Fixed Mount Vacuum Circuit Breakers
Reference Standards	ANSI/IEEE: C37.20.3, C37.04, C37.06

Flexible & Durable Enclosure Options

Standard Indoor: NEMA 1
Weatherproof Outdoor:
NEMA 3R Non-Walk-In
(stainless hardware, pad-
lockable doors)
APT PwrSkid: Outdoor Non-
Walk-In Skid-Mounted

Walk-in Solutions:
APT PwrContainer: Compact
Containerized Outdoor Walk-
In Enclosure
APT PwrHouse: Outdoor
Walk-In Enclosure

Material & Finish Options:
Carbon Steel, Aluminum,
Stainless Steel (304 & 316)
Powder-coated ANSI 61 Gray
or the color of your choice!

Automatic & Manual Transfer Controls



Figure 5*

Switch Smarter, Power Safer

Automatic Transfer Systems

- Open Transition (OT2)
- Closed Transition (CT1)
- Soft loading & Unloading (SL1)
- Automatic Return to Normal (AR) – Standard
- Operator-Supervised Return (NA) – Optional



Figure 6*

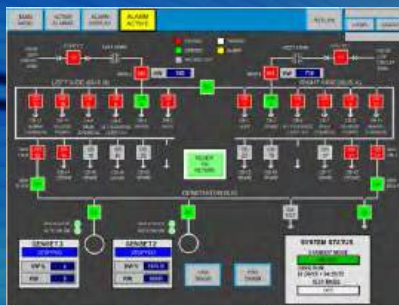


Figure 7*

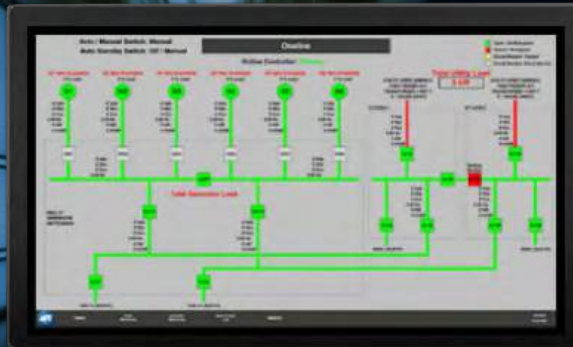


Figure 8*

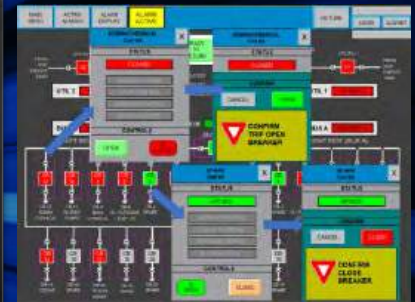


Figure 9*

Safe Maintenance, Minimized Downtime

Maintenance & Bypass Isolation

- Main-Tie-Main Operation (MTM)
- Automatic Bypass (ATO-BI)
- Manual Bypass/Isolation (BI)
- Manual Transfer (MT) w/Captive Key Interlocking
- Solenoid Key Release Bypass (SK)



Figure 10*

Advanced SCADA Controls - APTView

Demand Control, Simplified

- Advanced Load Management**
- Load Shed Prioritization (LSC)
 - Load Add Control (LAC)
 - Load Demand Optimization (LDC)



Figure 11*



Figure 12*

Advanced Master Control

- 20" minimum Touchscreen Display**
Microgrid & Island Mode Capabilities
- Black Start for Turbines
 - Island Mode Control (IM)
 - Microgrid Integration (MG)



**APTView
Enabled**

Control From Anywhere, Anytime

- SCADA & Remote Management**
- APTView Remote SCADA (AV)
 - External BAS Integration (BSI)



Figure 13*

*Due to ongoing product improvements, actual delivered products may differ from the images shown.
*Optional equipment features are frequently illustrated.
*Availability of options varies by product series.

Utility & Generator Sections

Simple To Service Modular Compartmentalized Switchgear

Our modular switchgear design is meticulously engineered for serviceability, reliability, and simplified integration, compliant with IEEE/ANSI, and component UL standards. Each specialized section is optimized and compartmentalizable to meet your exact application requirements.



Figure 14*

Incoming Main & Utility Intertie Feed Sections

- **Rated Voltage:** Up to 15kV, ensuring compatibility and safety with your utility grid.
- **Circuit Breakers:** Vacuum circuit breakers (VCBs) with withdrawable capability, simplifying maintenance and providing visible disconnect for operational safety.
- **Precision Instrumentation:** Integrated current transformers (CTs) and voltage transformers (PTs) configured for precise metering, monitoring, and protection.
- **Safety & Reliability:** Engineered with robust mechanical interlocks and clearly defined operational positions for maximum safety.

Incoming Generator Sections

- **Enhanced Paralleling Capabilities:** State-of-the-art synchronizing equipment for seamless integration and paralleling of generators.
- **Flexible Breaker Configurations:** Fully withdrawable VCBs rated for continuous operation and quick maintenance.
- **Advanced Protection:** Comprehensive relay and protective systems safeguard generator integrity and ensure fault tolerance.
- **Maintenance Ease:** Optimized compartment design provides easy access to critical components, minimizing downtime.

Tie, Distribution, Control Power Sections

Utility Bus Isolation Tie, Multi-Gen Bus Tie, Main-Tie-Main Sections

- **Robust Source Transfer:** Designed for dependable automatic or manual transfer between multiple power sources without service interruption.
- **Seamless Controls:** Equipped with intelligent transfer controllers capable of automatic and fast switching between the power sources.
- **Digital Integration:** Advanced digital relaying and metering enhance system monitoring and fault identification, improving uptime.
- **Maximum Flexibility:** Designed to accommodate various operational and expansion scenarios seamlessly.

Distribution Feeder Sections

- **Flexible Power Distribution:** Optimized layout to ensure efficient and secure distribution to downstream loads.
- **Comprehensive Protection:** Integrated CTs and PTs, meticulously engineered for accuracy and reliability in protection schemes and power management.
- **Expandability:** Future-ready provisions included, facilitating easy upgrades or expansions as your needs evolve.
- **High Short-Circuit Withstand:** Engineered internal bus bars with exceptional thermal and mechanical stress resilience.

Control Power Section

- Provides internally derived control power for ATS operation, eliminating the need for a customer-supplied 120VAC control circuit and ensuring the DC battery system maintains a reliable AC source for continuous charging and ride-through capability during source transitions.
- Supports small to large control power transformers (single- or three-phase), allowing the section to serve as a dependable source of station service power for external equipment and auxiliary systems requiring control power.



Figure 15*

Withdrawable Vacuum Circuit Breakers

APT's Withdrawable Vacuum Circuit Breakers (VCBs)

Engineered for seamless power system integration, our VCB combines a next generation compact Vacuum Circuit Breaker technology with our innovative compact withdrawable switchgear cells to ensure reliability, ease of maintenance and operational flexibility.



Figure 16*

Operational Simplicity & Familiarity

- **Withdrawable Removable Vacuum Circuit Breakers:** Provides visible disconnect of primary circuit to provide maintenance service on all types of downstream load equipment.
- **Integral Manual Charging Handle:** Allows for manual operation, ensuring ease of use without reliance on complex systems.
- **Test Position:** Allows for testing of every aspect of the circuit breaker manual and electrical operation (trip, charge, close, position contacts, etc.) while circuit breaker's primary terminals are fully disconnected from the switchgear cell.
- **Operation by any universal disconnect head hot stick** for operational flexibility, simplicity and enhanced operator safety. 4' hot stick is included with switchgear.

Enhanced Safety Mechanisms

- **Mechanical Interlocks:** Prevent withdrawal or insertion of the circuit breaker when main contacts are not open, ensuring operator safety.
- **Intermediate Position Lockout:** Breaker cannot be electrically or mechanically closed unless it is in fully connected or fully disconnected (in Disconnected or Test position), preventing unsafe operations.
- **Automatic Shutters:** Automatically cover primary connections when the circuit breaker is in Disconnected or Test position, or removed from the cell, reducing operator's exposure to live parts.
- **Stop bumpers:** Prevent circuit breaker from accidental rolling out of the cell on to the operator, when in Test/Disconnected Position.

Modern Simplicity Meets Proven Reliability



Figure 17*



Figure 18*

Ratings and Features

Available Ratings:

Maximum Voltages, kV	4.76 / 15
Power Frequency Withstand (1 minute), kV	19 / 36
BIL, kV	60 / 95
Continuous Current – Circuit Breakers, A	600, 800, 900, 1200, 2000, 3000**, 4000**
Continuous Current – Main Bus, A	600 - 4000
Interrupting Capacity – symmetrical, kA	25, 31.5, 40**, 50**
Short time withstand, 2 seconds, kA	25, 31.5, 40**, 50**
Mechanical endurance, operations	10,000 (class M2 per IEEE C37.04 and C37.06)
Interrupting Time	3 cycles
Opening Time	Less than 40ms

** Requires increased switchgear depth

- **High-Speed Operation:** Fault clearing in under 3 cycles with performance matching or exceeding industry-leading breakers, optimized for simplicity.
- **Rated Operation Sequences:**
 - O-0.3s-CO-15s-CO
 - O-0.3s-CO-3min-CO
 - O-3min-CO-3min-CO
- **Mechanisms and Interlocks:** Manufactured from stainless steel and other metals ensure reliable operation and ease of repairs.
- **Insulation:** No reliance of custom moldings or extrusions. Industry standard readily available insulation type and shapes used in construction.
- **Captive Key Mechanical Interlocking:** Multiple provisions and options available.
- **Single & Two High Vacuum Circuit Breakers Sections for Withdrawable or Fixed Mount**

Withdrawable Cell & VCB Removal

Additional VCB Cell Features

- **Shutters:** When the breaker is removed, the shutters automatically close, separating the compartment from energized components
- **Grounded Metal Compartments:** All live parts are enclosed in grounded metal compartments; the breaker frame remains grounded during levering and in the connected position, enhancing safety.
- **Front Accessible Breaker Secondaries:** Front accessible circuit breaker secondary connectors and harness provides visual assurance of secure secondary connections and easy access for maintenance and inspection.



Figure 19*



Figure 20*

Attachable VCB Roll Out Pan for Circuit Breaker Removal

- Locks into switchgear section frame and circuit breaker cell, allows to roll out and secure the circuit breaker outside of the switchgear cell
- Keeps circuit breaker secure in place to allow complete out of cell inspection without complete removal.
- Allows for use of conventional lifting devices including common engine lift/hoist to safely remove circuit breaker from the section and lower it to the floor.

Fixed Mount Breaker Option



Figure 21*



Figure 22*



Figure 23*

Single & Two High Vacuum Circuit Breaker Sections

- Fixed-mount vacuum circuit breakers are commonly used in distribution systems where reliable protection is required but breaker removal is not required during normal operation.
- Used in stable distribution systems where breakers remain installed for long service intervals.
- **Simplified Mechanical Operation:** Directly fixed mounted breakers eliminate racking systems and reduces the number of moving components, which reduces mechanical complexity while retaining the fast fault clearing and long service life of vacuum interrupter technology.
- **Resettable Protection for Rapid System Restoration:** Unlike fuse-protected feeders, vacuum circuit breakers can be reset after a trip, allowing operators to investigate and restore power without replacing fuses.
- **Improved Fault Diagnostics and Troubleshooting:** Protection relays and breaker trip indications provide valuable information following a fault event, helping operators determine the cause of the trip before returning equipment to service.
- **Reduced Downtime Compared with Fuse-based Protection:** Systems using fuses require replacement after operation, while circuit breakers allow controlled reclosing once the fault condition has been evaluated.
- **Compact Switchgear Configurations:** Fixed breakers can reduce switchgear depth and allow for back-to-back and two high arrangement sections.
- **Optional Visible Isolation When Required:** Where operational procedures require a visible disconnect, fixed VCB sections can be combined with an in-line load break or dead break disconnect switch.

Vacuum Interrupters & Cable Connections

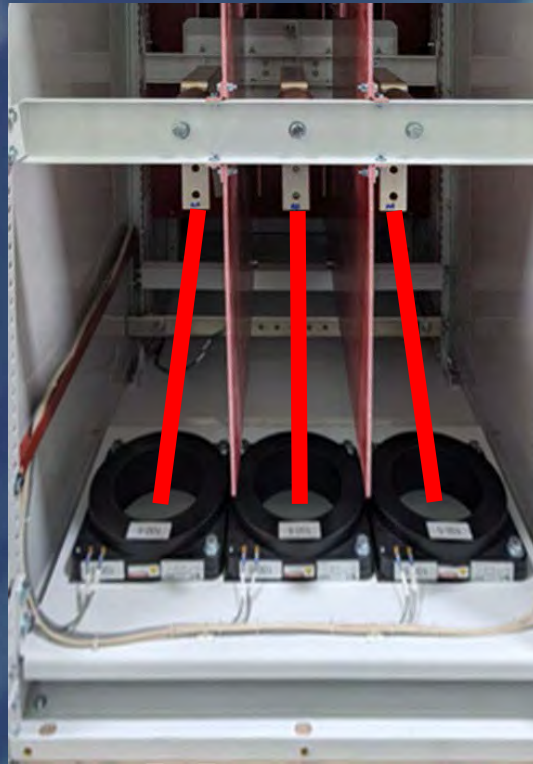


Figure 24*

Reliable Interruption & Long-Life Contacts

- **Hermetically Sealed Vacuum Interrupters:** Ensure extinguishing of the arc and protect contacts from contamination, extending the lifespan of the breaker.
- **Copper-Chromium Vacuum Interrupter Contacts:** Provide superior dielectric withstand, very low contact resistance and low contact wear, ensuring reliable operation.

Safe and Easy CT Maintenance with System Energized

- **Shielded Power Cables Pass Through the Current Transformers:** allows for maintenance and replacement of the current transformers when the circuit breaker is in the Test/Disconnected Position, all while the main bus remains energized, improving the continuity of service.

Innovative 15kV Main Bus



Figure 25*



Figure 26*

600A – 4000A Main Bus

- **Bracing Capacity:** Designed for systems ranging from 2.4kV to 15kV, with symmetrical short-circuit withstand capacities including 25kA, 31.5kA, and up to 50 kA and beyond, ensuring robust performance under fault conditions.
- **Performance:** These ratings offer flexibility and reliable performance, accommodating power systems with various available fault currents.
- **Ease of Accessibility:** via Front, Rear and Top depending on switchgear configuration.

Silver-Plated Copper Busbar

- **Nominal Bus Current Ratings Available in: 600A - 4000A @ 15kV max.****
- **Rated short-circuit withstand time: 2 Seconds**
- **Superior Conductivity:** Silver plating improves surface conductivity and ensures minimum contact resistance versus alternatives.
- **Low Heat Generation:** Lower resistance in silver-plated conductors can lead to reduced heat generation under high current loads.

**For voltages 17kV-38kV, please reference our 38kVmax. Switchgear Product Lines

Phase Barriers/Bus Segregation/Insulation



Figure 28*



Figure 27*

Phase Barriers and Bus Segregation*

- Insulating Barriers between phases eliminate the need for the taping of the cable connections simplifying and reducing the cost of installation. This also allows for easy visual, mechanical and electrical inspection of cable connections, simplifying the switchgear maintenance for the life of the installation.
- Insulating or grounded barriers are provided to separate main bus from the line and load connections, providing degree of protection for main bus from the faults in cable terminations as well as providing degree of protection for the qualified personnel working in the cable connection area while the main bus is energized.

Bus Insulating Covering Options*

- Switchgear buses are generally designed to meet the dielectric withstand requirements of 19/36 kV for one minute and BIL of 60/95 kV with “uninsulated bus” and therefore not be dependent on any insulating bus coverings.
- Optional heat shrinkable or fluidized bed epoxy type coverings are available to supplement the dielectric strength and provide degree of protection in case of accidental contact by small animals or persons. In this case bolted connections are covered with removable insulating boots.



Figure 29*



Figure 30*

Instrument Transformers – PTs, CTs



Figure 31*

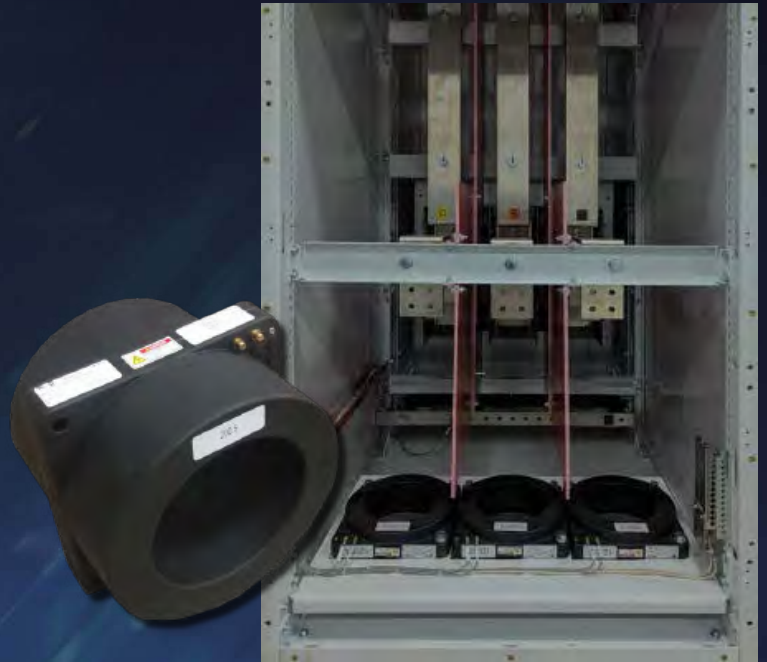


Figure 32*

Voltage Transformers (VTs/PTs)

- **Configurable Voltage Sensing:** Available in WYE or Open Delta configurations, Fixed or Drawer mounted, enabling precise voltage sensing tailored to specific application needs and system requirements.
- **Reliable and Accurate:** Accuracy Class 0.3WXM ensures accurate voltage measurements critical for protection, metering, and system monitoring.
- **Available on:**
 - Utility Sections for Line Side Incoming Main/Utility Sensing
 - Generator Sections for Line Side Incoming Generator Sensing
 - Single or Multiple Main Bus Sensing
 - Distribution Feeder Sensing

Current Transformers (CTs)

- **Diverse Application Support:**
 - Ratios: 50:5 - 4000:5
 - Relay Class: C10 – C400
 - ANSI Metering Class:
 - 4.8B0.1 – 0.15B1.8 and beyond
- **Precision Metering Options:** Available in standard accuracy or high-precision, revenue-grade metering accuracy to support critical measurement and billing applications.
- **Mounting Over Shielded Power Cables:** allows for maintenance and replacement of the load side current transformers (with the corresponding feeder circuit breaker in Test/Disconnected Position) while the main bus remains energized, significantly improving the continuity of service.

Flexible Voltage Sensing Drawers

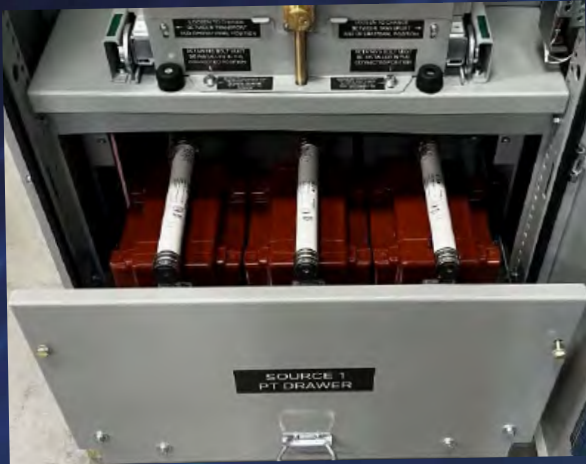


Figure 33*

Potential Transformer Drawer

- **Easy-Access PT Fuse Replacement:** Designed for quick, safe, and convenient fuse access and replacement, reducing maintenance time.
- **Automatic Safety Grounding:** Drawers and PTs are automatically grounded during the transition to the disconnected position for enhanced operator safety.
- **Insulated Mounting Assemblies:** Fully insulated to the system voltage rating, ensuring safety and reliable operation under all conditions.
- **Self-Aligning PT Drawer Contacts:** Self-aligning primary and secondary contacts ensure secure electrical connections.

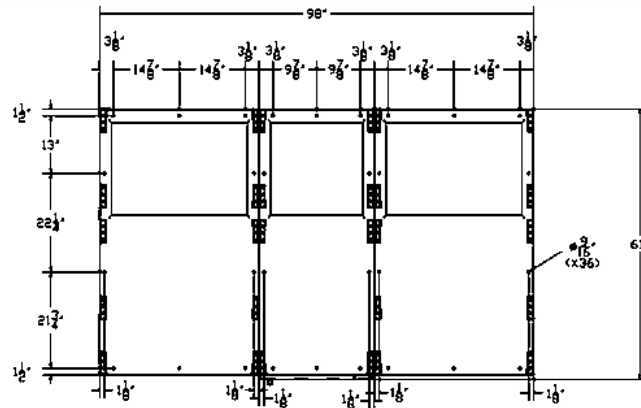
Switchgear Sections with PT Drawer Configurations

- **PT Drawer/Breaker or Breaker/PT Drawer (up to 2 Drawers):**
 - Open Delta (PT-D)
 - WYE (PT-Y)
 - CPT or CPT Fuses
 - Top or Bottom cable entry.
- **Multiple PT Drawers Section (Up to 3 Drawers per section):**
 - PT-D or PT-Y drawer arrangements.
 - Flexible selection of bottom or top cable entry to meet site-specific installation requirements.
- **Dedicated PT/Metering Sections:**
 - Configurable for Main, Generator, Load, or Bus applications.
 - Open Delta (PT-D), Wye/Wye (PT-Y), or Grounded Wye Broken Delta

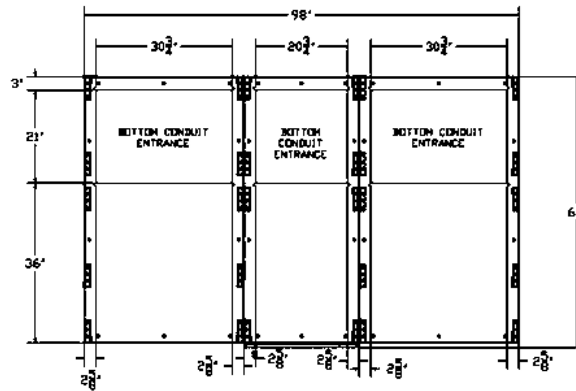


Figure 34*

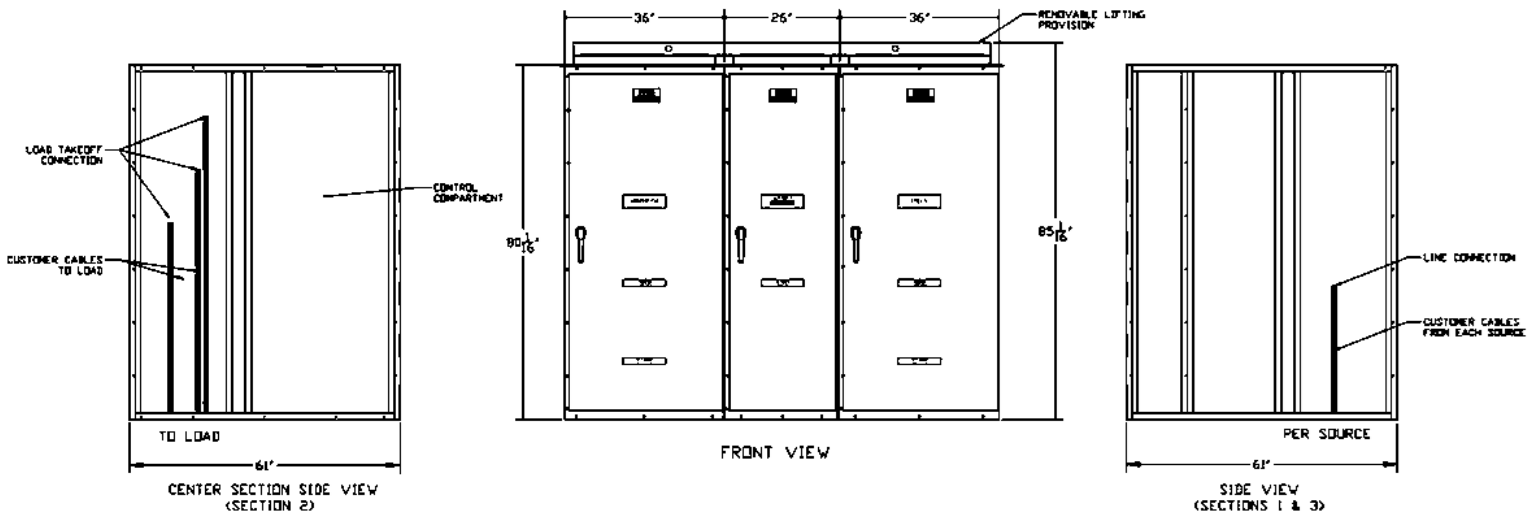
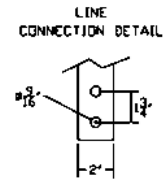
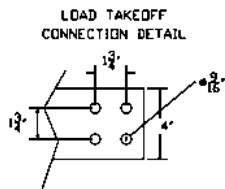
Installation Drawings: MED-15-3R-BB-VW



SECTION A-A
(ANCHORING)

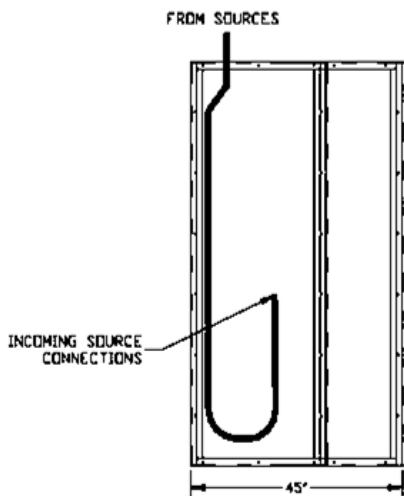
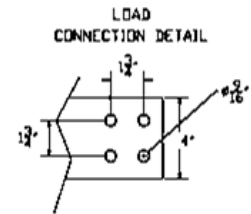
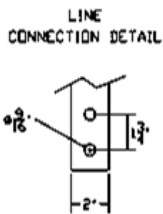
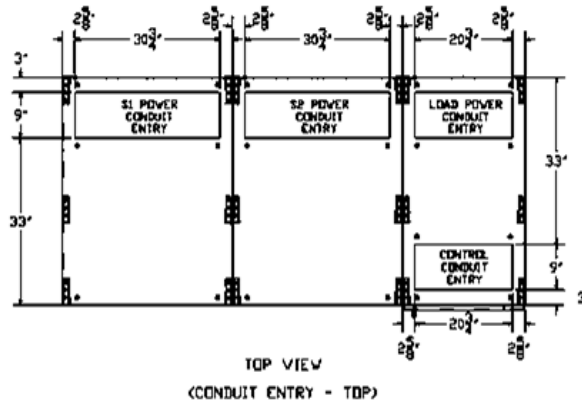
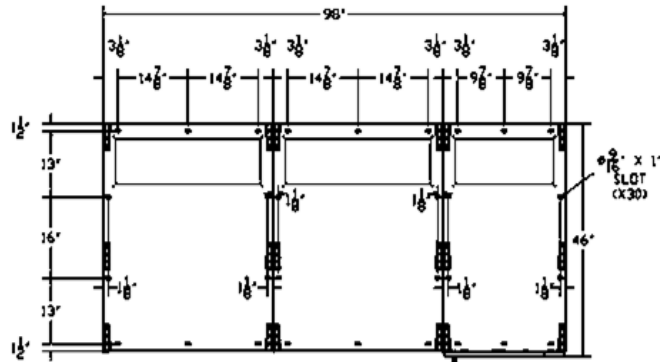


SECTION A-A
(CONDUIT ENTRANCE)

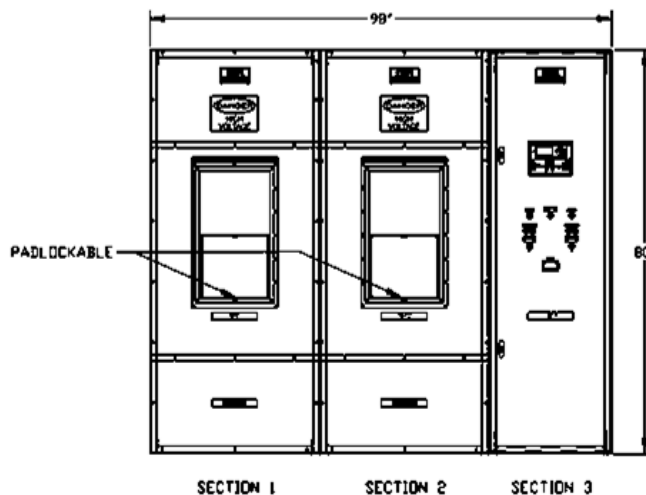


MED-15-3R-BB-VW: APT MED-Series 5kV-15kV, 600A Outdoor, NEMA 3R, Bottom Entry for Line side Cables, and Bottom Exit for Load side Cables, using one Withdrawable Vacuum Circuit Breaker per power source

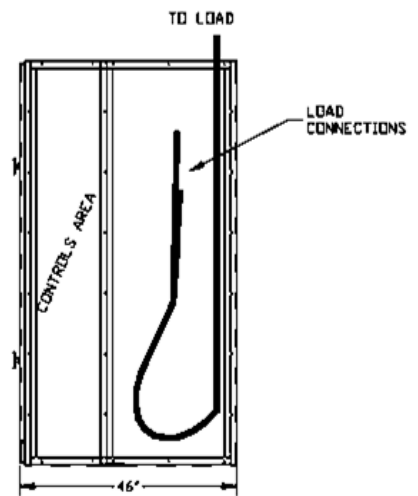
Installation Drawings: MED-15-1S-TT-VF



LEFT SIDE VIEW
(SECTIONS 1 AND 2)



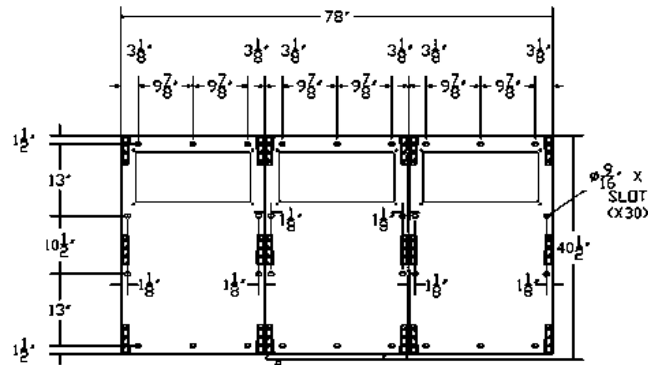
FRONT VIEW



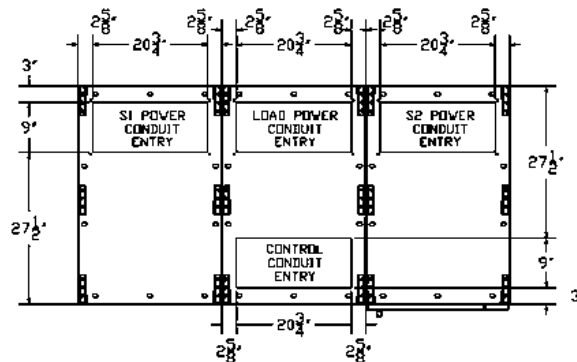
RIGHT SIDE VIEW
(SECTION 3)

MED-15-1S-TT-VF: APT MED-Series 5kV-15kV, 600A Indoor, NEMA 1, Top or Bottom Entry for Line side Cables, and Top or Bottom Exit for Load side Cables, using one Fixed Mounted Vacuum Circuit Breaker per power source

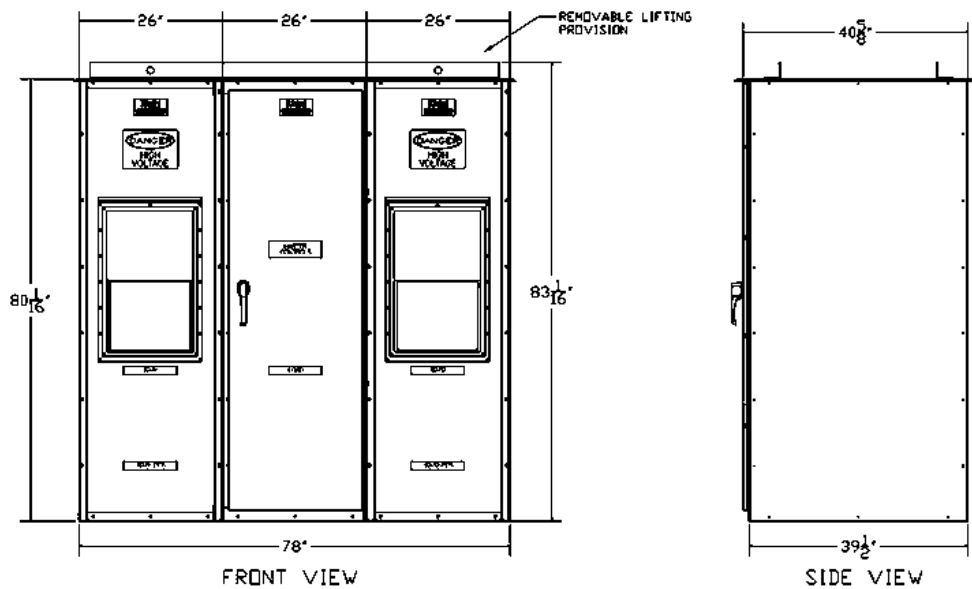
Installation Drawings: MED-05-3R-BB-VF



PLAN VIEW
(ANCHORING)



PLAN VIEW
(CONDUIT ENTRY - BOTTOM)



FRONT VIEW

SIDE VIEW

MED-05-3R-BB-VF: APT MED-Series 5kV*, Indoor/Outdoor, Bottom cable entry, using one Fixed Mounted Vacuum Circuit Breaker per power source. Add 6" to the depth for 15kV or Top/Bottom cable entry.

Protective Relaying Functions



Figure 35*



Figure 36*

Digital Multifunction Relays

APT uses industry-leading relay brands such as SEL, GE Multilin, Basler, Beckwith, ABB, Eaton, Siemens and more for overcurrent, voltage, frequency, differential, distance, directional power and ground fault protection in the following applications:

- Utility Intertie
- Paralleling Protection
- Advanced Generator Protection
- Tie Protection
- Transformer Protection
- Feeder Protection
- Various Differential Protection Schemes

All devices are factory-labeled and documented in submittals with wiring diagrams.

Common Relaying functions

- 50/51 – Inst./Time Overcurrent
- 50N/51N – Inst./Time Ground Overcurrent
- 27/59 – Under/Overvoltage
- 59N – Ground Overvoltage
- 81U/81O – Under/Overfrequency
- 25 – Synch Check
- 32 – Reverse Power
- 40 – Loss of Excitation
- 60 – Current Balance
- 67 – Directional Overcurrent
- 86 – (LO) Lock-Out Relay (Knob Grip)
- 87 – Differential Protective Relay
- 87B – Bus Differential
- 87G – Generator Differential
- And More!

Lockout Relays & Test Switches

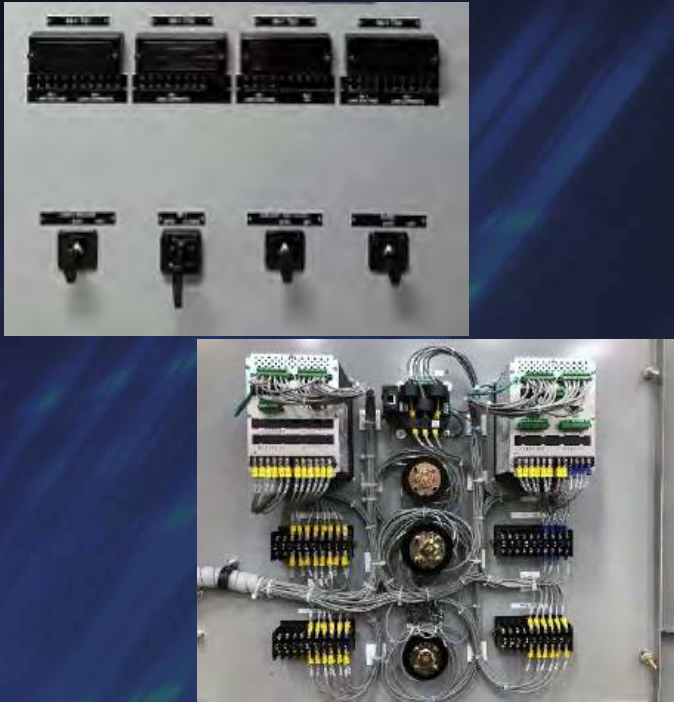


Figure 37*

Lockout 86 Function

- **Fail-Safe Design:** Designed to remain in the lockout condition until manually or electrically reset, ensuring full inspection before re-energization.
- **Knob-Grip Manual Reset:** Heavy-duty mechanical lockout relay with a manual reset knob. Activates on critical protection trips to disable automatic reclosing.
- **Visible Mechanical Target:** Red "TRIPPED" indicator shows at-a-glance breaker lockout condition.

Optional Test Switches & Test Plugs

- Provide a safe, simple, fast, and reliable method to isolate, test, and service installed equipment without disturbing the power system.
- Permits convenient isolation of relays, meters, and instrument transformers (PTs & CTs).
- Allows for quick and easy multi-circuit testing by conventional test methods.
- **Test Plug:** Enables easier measurement, calibration, verification and maintenance of relays, meters, PTs, & CTs.
- Conveniently connects external instruments to the same currents and voltages being applied to the panel relays and meters by the PTs, & CTs, without interrupting or short-circuiting the circuit.



Figure 38*

Power Sensing & Revenue Grade Metering



Figure 39*



Figure 40*

High Accuracy Power Quality Metering

METERING			
Parameters	Accuracy	Resolution	Range
Voltage	0.5%	0.1V	20V 1000kV ~
Current	0.5%	0.001A	0 ~ 50000A
Current Demand	0.5%	0.001A	0 ~ 50000A
Power	0.5%	1W	-9999MW 9999MW ~
Reactive Power	0.5%	1Var	-9999Mvar 9999Mvar ~
Apparent Power	0.5%	1VA	0 ~ 9999MVA
Power Demand	0.5%	1W	-9999MW 9999MW ~
Reactive Power Demand	0.5%	1Var	-9999Mvar 9999Mvar ~
Apparent Power Demand	0.5%	1VA	0 ~ 9999MVA
Power Factor	0.5%	0.001	-1.0 ~ 1.0
Frequency	0.2%	0.01Hz	45.00 ~ 65.00Hz
Energy	0.5%	0.1kWh	0 ~ 99999999.9kWh
Reactive Energy	0.5%	0.1kvarh	0 ~ 99999999.9kvarh
Apparent Energy	0.5%	0.1 VAh	0 ~ 99999999.9kVAh
Harmonics	1.0%	0.01%	
Meter Running Time		0.1hrs	0 ~ 99999999.9hrs
Load Running Time		0.1hrs	0 ~ 99999999.9hrs

- Optional Revenue Grade
 - Active Energy Accuracy according to ANSI C12.20: Class 0.2s
- Optional Data Logging
- Optional Time of Use
- Optional Waveform Capture & Event Logging
- Optional Harmonic Resolution to the 63rd

Standard Advanced Metering Functions

- Voltage: $V_A, V_B, V_C, V_{AB}, V_{BC}, V_{CA}$
- Current: I_A, I_B, I_C, I_N
- Power: P_A, P_B, P_C, P_{sum}
- Reactive Power: Q_A, Q_B, Q_C, Q_{sum}
- Apparent Power: S_A, S_B, S_C, S_{sum}
- Frequency: F
- Power Factor: PF_A, PF_B, PF_C, PF
- Energy: $E_{pimport}, E_{pexport}$
- Reactive Energy: $E_{qimport}, E_{qexport}$
- Apparent Energy: E_s
- Demand: $Dmd_{IA}, Dmd_{IB}, Dmd_{IC}, Dmd_P, Dmd_Q, Dmd_S$
- Power Quality
- Voltage Harmonics: 2nd - 31st and THD
- Current Harmonics: 2nd - 31st and THD
- Voltage Unbalance Factor: U_{unbl}
- Current Unbalance Factor: I_{unbl}
- Max/Min Statistics
- Meter Running Time and Load Running Time
- Pulse Output option
- RS485, industry standard Modbus RTU protocol
- Alarm Parameters
- Active Energy Accuracy according to ANSI C12.20: Class 0.5s

Switchgear Surge Arresters

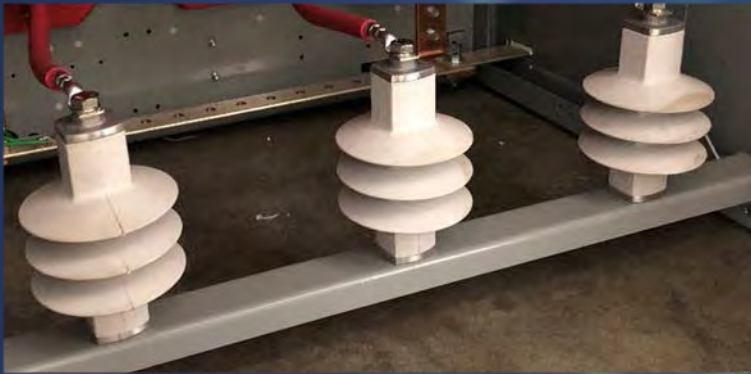


Figure 41*

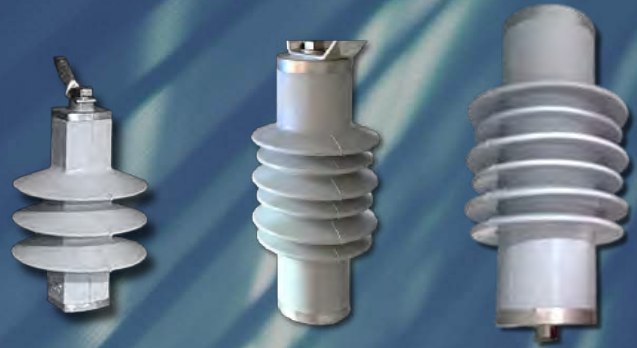


Figure 42*



Figure 43*

Available Arresters Characteristics & Classes

- **Metal-Oxide Varistor (MOV) Design:** Gapless design ensures fast, consistent clamping without triggering delays.
- **Polymer Encapsulated Housing:** UV- and weather-resistant for long-term performance.
- **Maintenance-Free:** No required service or inspections over arrester life.
- **Placement Options:** Configurable for incoming lines, main bus taps, and feeder sections depending on system exposure and equipment sensitivity.

Class	Use Case	Key Performance Features
Distribution Class	General duty protection for 15 kV systems	<ul style="list-style-type: none"> • Available in light, normal, and heavy duty • Compact size • Ideal for transformer and feeder protection
Intermediate Class	Enhanced protection for moderate surge environments	<ul style="list-style-type: none"> • Better clamping performance than distribution • Higher energy handling • Rugged, compact design for switchgear integration
Station Class	Highest-performance arrester for critical assets	<ul style="list-style-type: none"> • Best voltage protection • Highest energy and fault current withstand • Preferred for rotating machinery protection

Integrated Protection for Medium Voltage Switchgear

APT switchgear integrates high-performance metal oxide surge arresters to protect 2.4–15 kV systems from transient overvoltages caused by lightning strikes and switching surges. These arresters safeguard critical components; such as breakers, buses, and transformers as well as loads by limiting voltage to safer levels during surge events.

Surge Capacitors and RC Snubbers



Figure 44*

Integrated RC Snubber Features

- **IEEE C57.142-2010 Compliant:** to meet transformers transient mitigation standard.
- **Controls Steep Voltage Rises:** Reduces dV/dt to protect winding insulation in transformers and rotating machines.
- **Suppresses Oscillations & Ringing:** Damps resonance from switching or current chopping events.
- **Protects Against Switching & Lightning Surges:** Complements surge arresters to reduce fast waveform overshoots.
- **Non-inductive components:** Features non-inductive resistors and capacitors.
- **Integrated in switchgear or Optional Standalone Cabinet:** Remote-mounted version for installation next to or in the transformer enclosure. Ideal for use with outdoor transformers or legacy switchgear installations. See APT's SurgeStop-Series RC Surge Snubbers.

Reducing Fast Transients Protecting Equipment

- Fast transients caused by vacuum breaker switching—such as current chop, prestrike, or re-strike—can result in steep voltage waves that exceed what standard surge arresters are designed to suppress. These fast-rising impulses can overstress insulation systems and cause premature transformer or motor failures.
- Extends Transformers, Generators & Motors Life: Prevents insulation stress from repeated high-frequency transients.
- Improves Switching Safety: Reduces pre-strike/re-strike effects during breaker operation.
- Recommended to be installed next to the protected equipment: Transformer, Generator or Motor.



Figure 45*

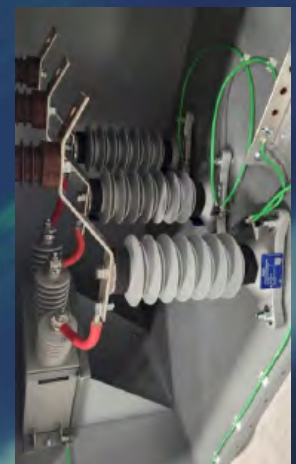


Figure 46*

Outdoor Walk-In Switchgear Enclosures

Engineered Precision, Delivered Performance

APT's **PwrHouse** and **PwrContainer** enclosures deliver industry-leading reliability, flexibility, and rapid deployment capabilities. Each solution is fully customizable to precisely meet your specific site and operational requirements, ensuring robust performance for critical power infrastructure.



Figure 47*



Figure 48*

Custom Modular Enclosures: Built for Specialization

PwrHouse:

- Tailored dimensions and modular flexibility to application-specific requirements.
- Fully integrated switchgear delivered ready for rapid commissioning.
- Robust construction adhering to stringent structural and environmental standards.
- Galvanized steel structure.
- Kynar 500 coated galvalume panels.
- Eliminates the need for shipping splits with compact, integrated switchgear design.
- Optional enhancements for critical operational conditions.

ISO Container Enclosures: Compact, Mobile, & Ready

PwrContainer:

- 20', 40', 45' ISO container-based, engineered for portability and immediate operational readiness.
- Ideal for rapid global deployment.
- Factory integrated switchgear and equipment in one self-contained unit significantly reducing on-site installation time.
- Easily Transportable by standard logistics networks: truck, rail, or ship.
- Optional features to withstand marine-grade environments, extreme seismic events, and Category 5 hurricanes available upon request.
- Optional Enhanced Marine-grade reinforced structural integrity with corrosion-resistant finishes and integrated environmental control.

APT PwrHouse – Walk-In Enclosure

Custom-Built Durability and Integration

APT's PwrHouse walk-in enclosures are meticulously engineered and factory-integrated to ensure structural integrity, durability, and simplified onsite deployment, explicitly designed to accommodate critical electrical systems safely and efficiently.



Figure 49*

Precision Engineered Modular Solutions

- **Robust Structural Integrity:**
 - Galvanized structural steel framing exceeding building code requirements.
 - ASTM A36 steel base ensures structural integrity for lifting and placing fully loaded enclosures.
 - Multi-rib panels with Kynar 500 finish, offer superior corrosion resistance.
 - Standing-Seam Metal Roof with UL 580 Class 90 Roof Uplift Certification.
- **Enhanced Safety & Comfort:**
 - Insulated steel doors with heavy-duty stainless-steel hinges and panic hardware.

Factory-Built for Rapid Onsite Deployment

- **Flexible Sizing & Rapid Deployment:**
 - Delivered fully integrated with no field assembly of internal components needed.
 - Compact design streamlines logistics, reduces installation time, and accelerates commissioning.
- **Compliance and Excellence:**
 - Detailed, accurate submittal documentation streamlines project approvals, reduces engineering, and installation risks.

Rapid, Efficient, & Robust Deployment

Engineered within ISO-certified sea-worthy containers, APT's PwrContainer enclosures offer unmatched portability, rapid deployment, and comprehensive environmental resilience for permanent & temporary global urban & rural operations and emergency response scenarios.



Figure 50*

Rugged, Robust Design ISO Container-Based Design

- **Superior Mobility and Reliability:**
 - Modified ISO shipping containers (20', 40', 45') allow international mobility, ideal for permanent, temporary, emergency, urban, or remote sites.
 - Eliminates onsite assembly; containers arrive fully tested and ready to operate immediately upon placement and acceptance testing.
- **Optional Marine-Grade Construction & Protection:**
 - Heavy-duty, reinforced steel framing and structural floor replacement ensures seismic stability and Category 5 hurricane resistance.
 - Corrosion-resistant marine-grade paint provides exceptional durability and heat deflection.

Fully Integrated Plug-and-Operate System

- **Enclosure Features:**
 - Insulated personnel doors with quick-escape panic hardware.
 - Closed-cell polyurethane foam insulation protects internal equipment from temperature extremes and condensation.
- **Integrated Systems and Optional Features:**
 - For additional customizable features such as corrosion-resistant coatings, HVAC redundancy, marine-grade protections, and advanced operational safety enhancements, please see the comprehensive list of optional features provided on the following page.

Optional Walk-In Enclosure Features

Tailored Optional Features

Customize your APT Walk-In Enclosure with specialized enhancements designed to maximize performance, reliability, safety, and adaptability for your exact operational needs.



Figure 51*



Figure 52*

Environmental Control & Interior Options

- (WA) – Climate-Controlled HVAC Systems (Heating, AC, Humidity Control)
- (WR) – Redundant Dual HVAC Systems with Automatic Lead-Lag Changeover
- (WH) – Anti-Condensation Aisle Strip Heating
- (WS) – Humidity Control System with Integrated Humidistat
- (WM) – Motorized Louvers for Optimized Ventilation
- (WN) – Corrosion-Resistant HVAC Coils
- (WL) – Enhanced Interior LED Lighting (≥ 300 lux)
- (WF) – Aluminum Diamond Plate Flooring
- (WK) – Non-Skid Epoxy Flooring

Optional Additions & Features Available

- (RD) – Rear Access Doors
- (WW) – Hinged Wireway
- (WC) – Cable Tray
- (WE) – Eye Wash Station
- (WU) – Corrosion-Resistant Aluminum Panels (PwrHouse Only)
- (WV) – Marine-Grade Corrosion Protection
- (WP) – Advanced Panel Insulation
- (WI) – Install UPS/BESS System
- (WD) – Control Room Desk
- (WJ) – Interior Divider Wall
- (WG) – Arc-Gas Venting Plenum System
- (WO) – Overhang Over Entrance Doors
- And more!

Application One-Line Diagrams

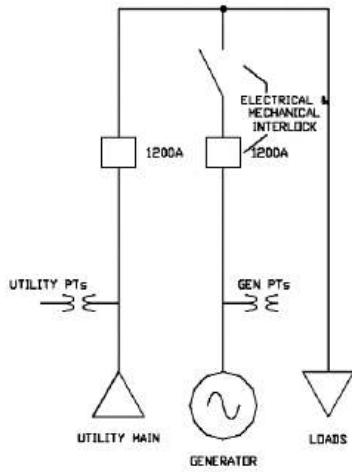


Figure 53*

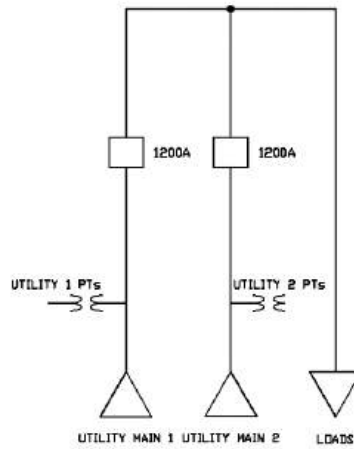


Figure 54*

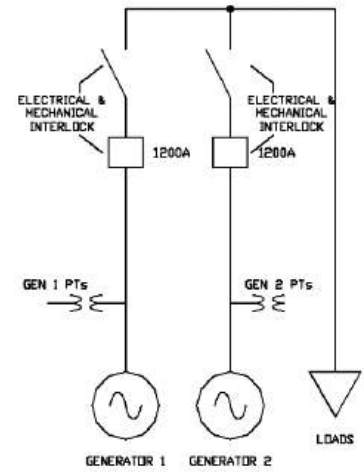


Figure 55*

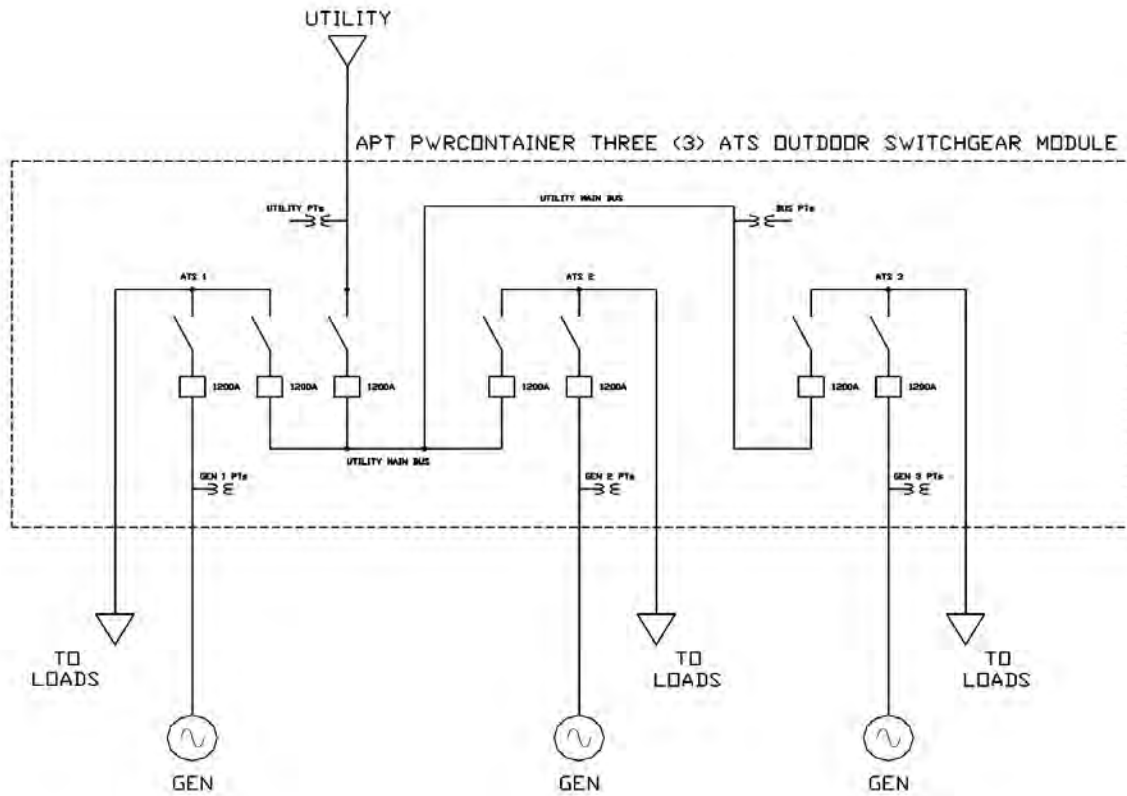


Figure 56*

About Advanced Power Technologies



Advanced Power Technologies (APT) is a leading innovator in engineered low and medium voltage power systems, delivering customized solutions worldwide. From our strategically central headquarters in Lafayette, Indiana, we design and manufacture precision-crafted switchgear, switchboards, and electrical infrastructure systems.

Decades of Expertise, Customized Solutions

Our skilled engineering team brings extensive experience across industries such as utilities, data centers, healthcare, agriculture, education, and commercial manufacturing. Leveraging cutting-edge switchgear technologies, we specialize in:

- 208V-800VAC Switchgear & Switchboards
- 2.4kV-38kV Custom Metal Enclosed/Clad Style Switchgear
- Generator Enclosure Package Integrated Equipment
- Utility and Generator Paralleling, Transfer, Peak Shaving & Distribution Switchgear
- Automatic & Manual Load Transfer Switchgear
- Outdoor Walk-In Electrical Houses (E-Houses) & Skid-Mounted Switchgear
- Containerized Switchgear & Battery Energy Storage Systems (BESS)
- Generator/Load Bank Quick Connection Switchgear, Switchboards, & Tap Boxes
- Microgrids, Master Control Panels, SCADA Systems
- Low & High Resistance Grounding Systems
- Bypass/Isolation & Power Distribution Circuit Breaker Switchboards
- Photovoltaic (PV) Solar Power Collection & Renewable Energy Storage Systems
- Motor Control Centers & Motor Control Switchgear
- High Efficiency Combined Heat and Power (CHP, Co-generation) Switchgear & Control Systems
- Industrial Control Panels

Precision Manufacturing & Innovation

APT proudly offers complete in-house, Made-in-USA manufacturing with precision metal fabrication capabilities, ensuring unparalleled quality, rapid turnaround, and tailored solutions that meet your exact specifications. As an OEM partner with industry leaders like Siemens, Square D, ABB, LG, and Eaton/Cutler Hammer, we integrate superior components into every system.

Flexible, Efficient, Scalable Solutions

APT provides highly flexible solutions with efficient production processes and scalable manufacturing capacities, tailored specifically to meet the demands of high-volume customers. Our capabilities position us ideally to serve large-scale operations including oil and gas producers, large data centers, extensive solar portfolios, and projects specified by leading engineers and facility managers.

Compact, Efficient, Reliable

APT excels at optimizing facility footprints and reducing installation costs through innovative, space-efficient designs. Each project benefits from our collaborative approach, open communication, and relentless commitment to customer success.

Discover more at www.appt-power.com, and let APT engineer the perfect power solution for your facility.