



ADVANCED POWER
TECHNOLOGIES

2.4kV-38kV Load Interrupter Switchgear (LIS)



MES-Series Metal Enclosed Switchgear Solutions Brochure

www.appt-power.com
433 N. 36th Street
Lafayette, IN 47905
(765) 446-2343

**SAFE SMART SERVICEABLE SWITCHGEAR &
ENGINEERED POWER SYSTEM SOLUTIONS**



ALN: 539 Rev. 01

Standard Construction



Figure 1: Indoor NEMA 1 Section Switching Device with Overcurrent Protection

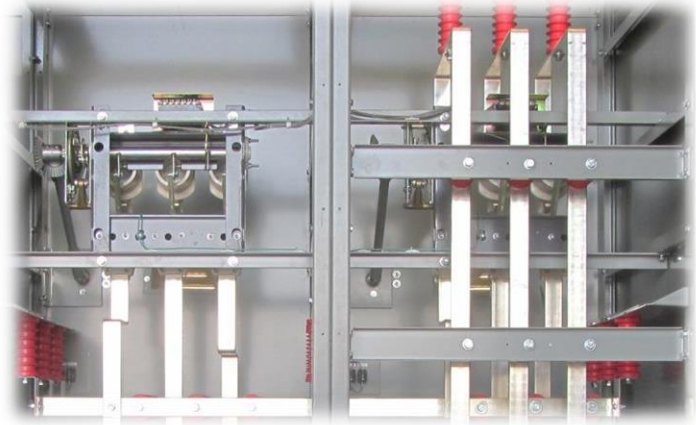

Figure 2: Optional Main bus is silver plated copper with bolted

200A – 1200A, 2.4kV-38kV (3Ø) Load Break Switch

- ⊙ Applications:
 - Utility Protection and/or Disconnection
 - Generator Protection and/or Disconnection
 - Transformer Primary and/or Disconnection
 - Motor Protection and/or Disconnection
- ⊙ System Ratings:
 - Voltage: 2.4kV-38kV (3Ø)
 - Current: 200A-1200A (3Ø)
- ⊙ Available as Front Access Only
- ⊙ Silver plated copper bus
- ⊙ Optional 12" Cable Pull Section
- ⊙ Each load braking switch section is provided with a Lexan viewing window for observing visual air disconnect switch position
 - Viewing window gives an operator full view of the position of all three switch blades
- ⊙ Overcurrent Protection (optional)
 - Current Limiting Fuses
 - Full Range, General Purpose, Back-Up
 - Characteristic Ratings:
 - A-Rated, E-Rated, R-Rated
 - Amp Rating: 50 – 1200A
- ⊙ Enclosure
 - Carbon Steel
 - Powder coated ANSI 61 Gray
 - NEMA 1 for indoor installation
 - NEMA 3R for outdoor installation
 - Anti-condensation Heater for Internal Climate Control
 - All hardware is stainless steel
 - Door handles are padlockable
 - Typical Dimensions (Up to 15kV design):
 - 100"H x 40"W x 41"D

SF6 Free Load Break Switch



Figure 3: Open Air Insulated Switch

2.4kV-38kV (3Ø) Load Break Disconnect Switch

Disconnect Insulation Type	Open Air Insulated
Mechanism Types	Snap Action K Mechanism Stored Energy A Mechanism
System Max kV/ Momentary Ratings	4.76kV/40kA 15kV/40kA 17kV/40kA 27kV/40kA 38kV/40kA
BIL Ratings	60kV – 150kV
Switch Amperage Ratings	200 Amps 600 Amps 1200 Amps
Air Insulated Pole Spacings	5.9in. – 14.1in.
Auxiliary Contact Switches	None 3 N.O. – 3 N.C. contacts 4 N.O. – 4 N.C. contacts
Handle Types	No Handle Chain Drive Handle w/o Door Interlock Chain Drive Handle w/Standard Door Interlock Chain Drive Handle w/Offset Door Interlock Direct Drive HE Shaft Drive [Manual w/No Motor] HM Shaft Drive [Use w/NM Motor]
Reference CAD Drawing - Switch Only	Available Upon Request

Indoor NEMA 1 Drawings

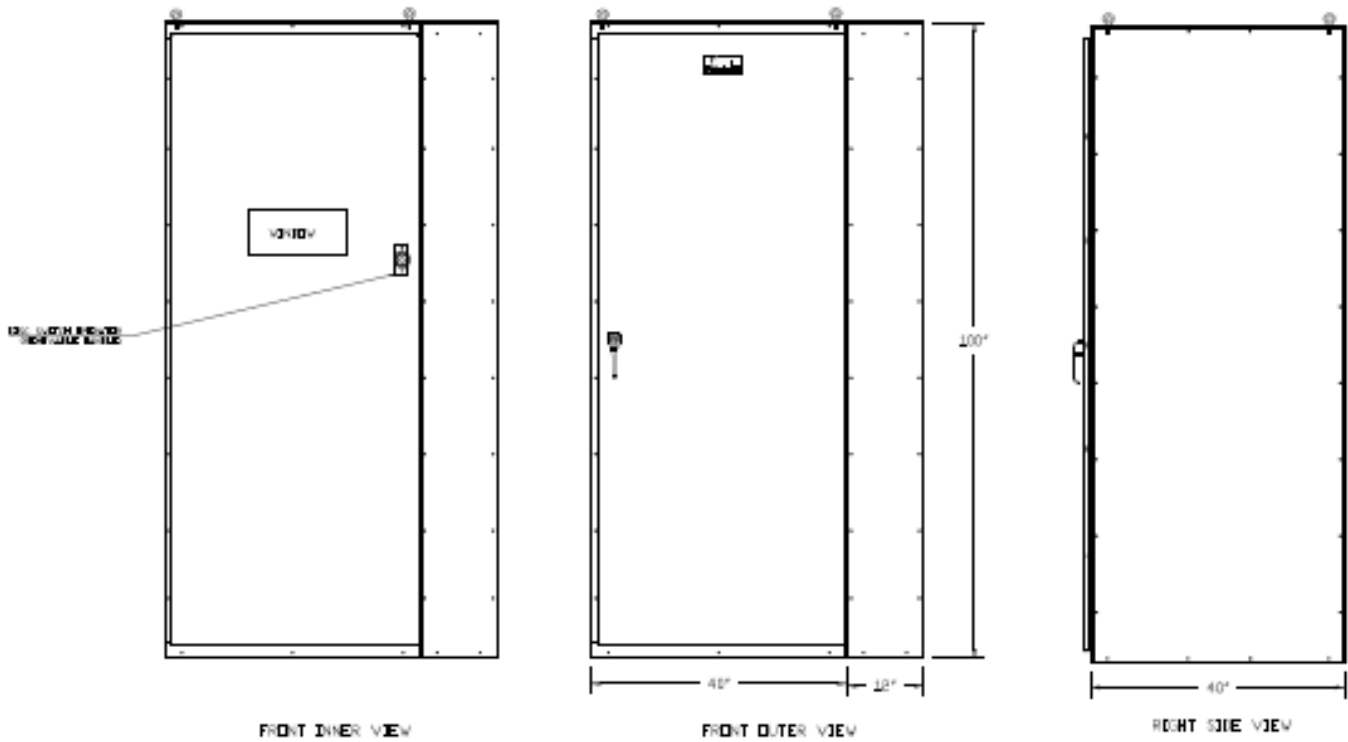
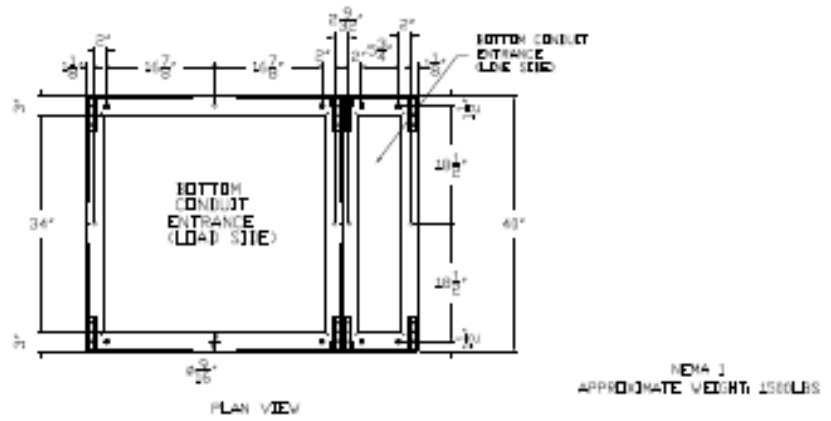

Figure 4: Indoor NEMA 1 with Line Side Bottom Conduit Entrance Through Optional Side Pull Section & Load Side Bottom Cable Exit

Outdoor NEMA 3R w/Base Drawings

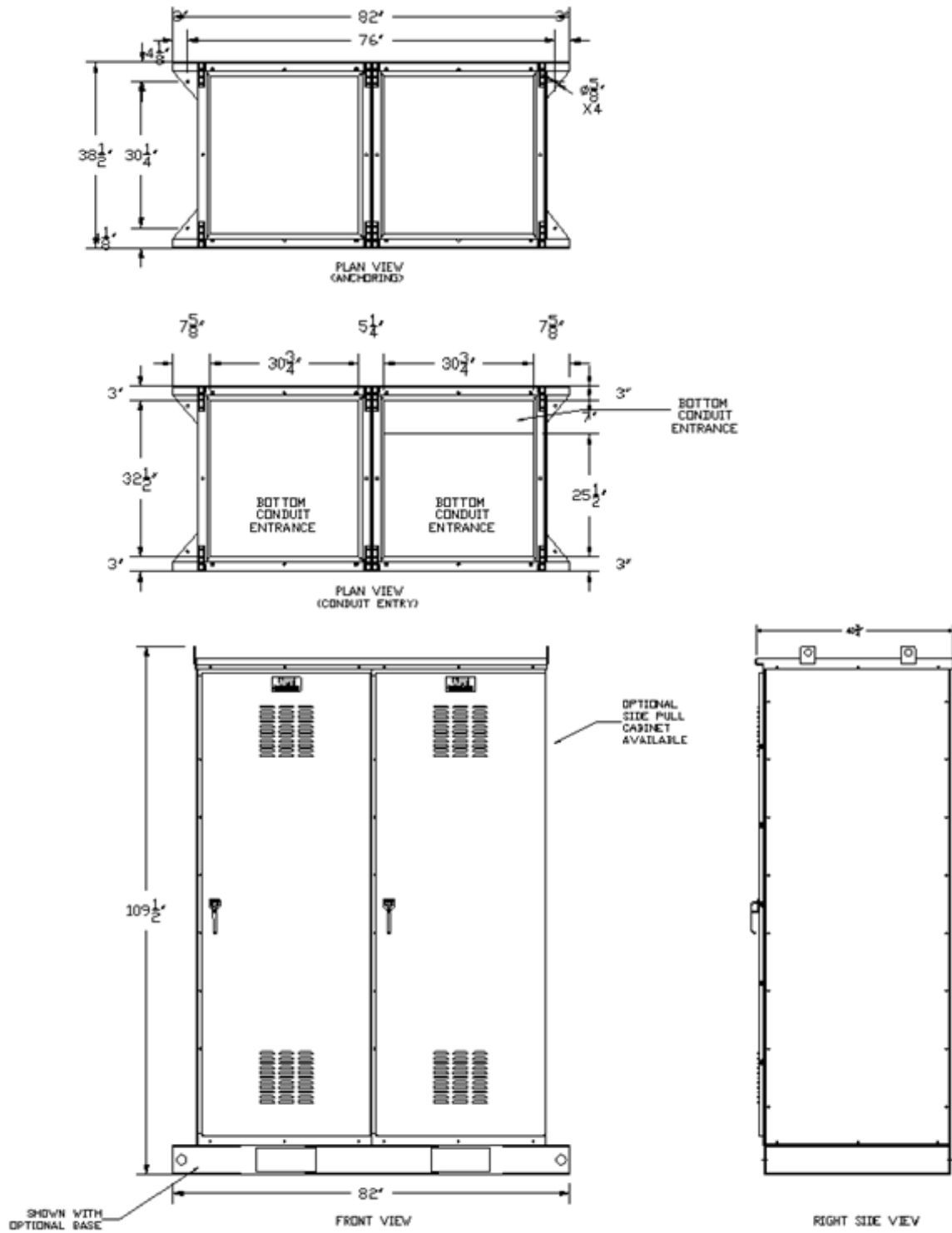

Figure 5: Two Motor Disconnects Outdoor NEMA 3R with Line & Load Side Bottom Conduit Entrance without Optional Pull Section Mounted to Switchgear Base

Outdoor NEMA 3R No Base Drawings

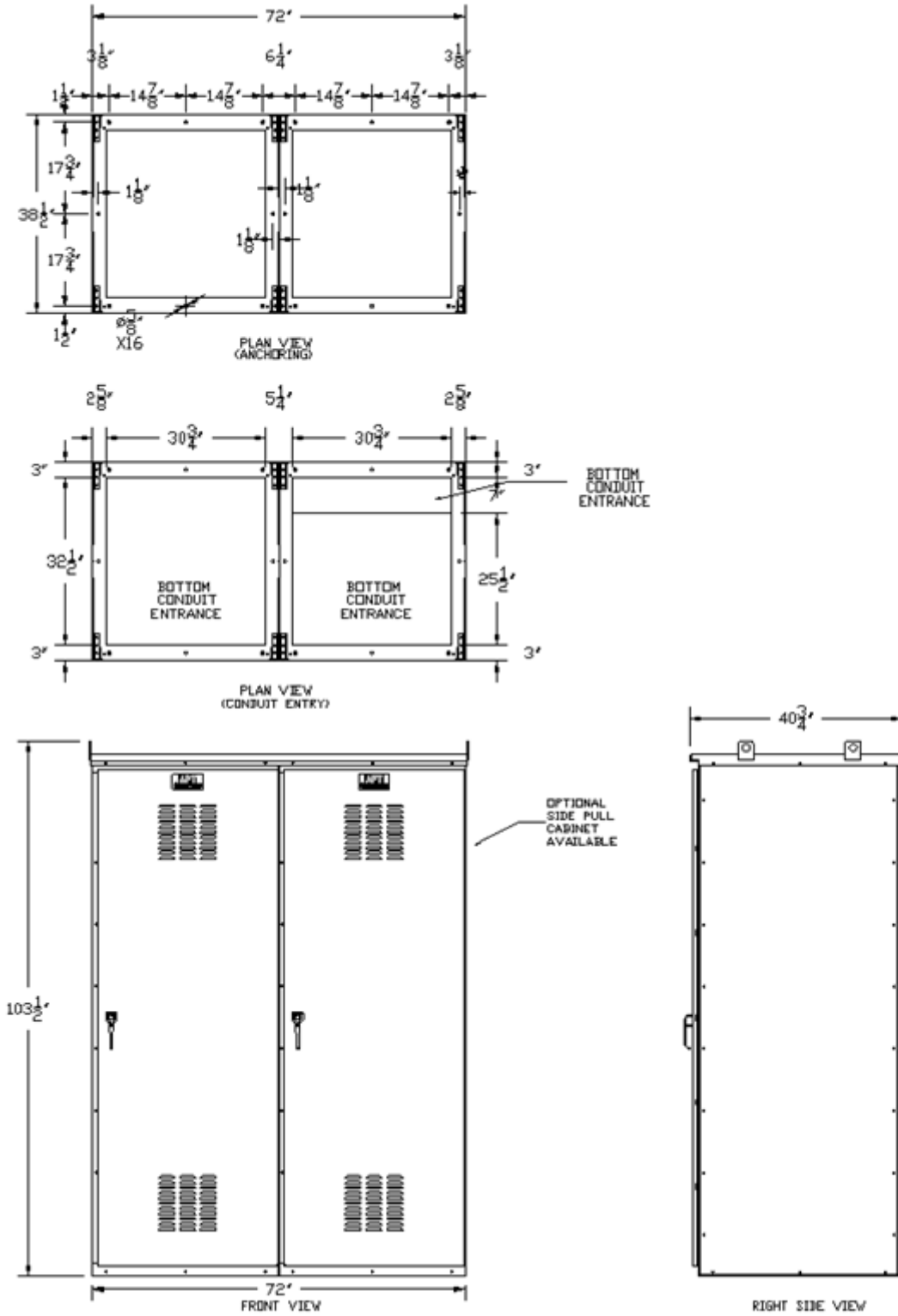

Figure 6: Two Motor Disconnects Outdoor NEMA 3R with Line & Load Side Bottom Conduit Entrance without Optional Pull Section

Typical Applications for MES-Series

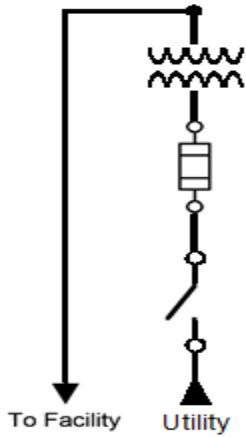

Figure 7: Transformer Primary Overcurrent Protection & Disconnection Switch

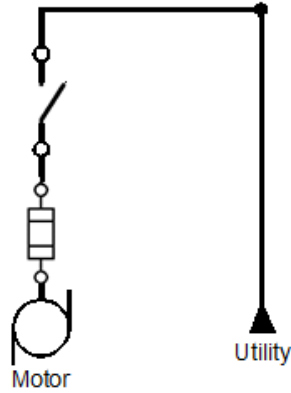

Figure 8: Motor Overcurrent Protection & Disconnection Switch

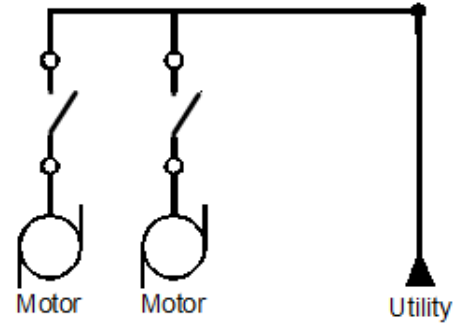

Figure 9: Motor Load Break Disconnection Switch

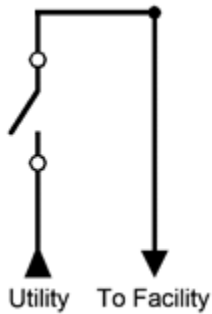

Figure 10: Utility Source Disconnection, Overcurrent Protection by Others

Utility
 Disconnection &
 Protection

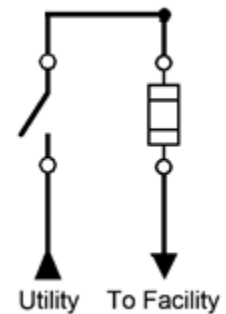

Figure 11: Utility Disconnection with Fused Overcurrent Protection

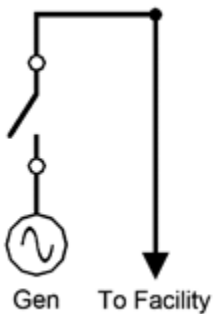

Figure 12: Generator Source Disconnection, Overcurrent Protection by Others

Generator
 Disconnection &
 Protection

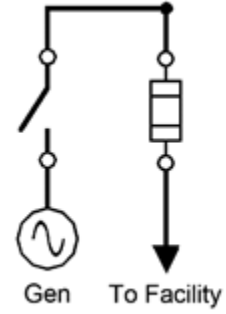

Figure 13: Generator Disconnection with Fused Overcurrent Protection

About Advanced Power Technologies



Advanced Power Technologies (APT) is on the cutting edge of the latest engineered power system smart technologies, as it relates to microgrid & storage management, renewable & conventional energy source deployment, demand peak shaving, and facility back-up and co-generation power systems. Located in the central United States and headquartered in Lafayette, Indiana with solutions development engineers around the country, APT provides domestic and international products and services to industry leading companies from around the world. APT engineers have decades of power system experience from working with some of the largest companies in industry. Over the last two decades, we have produced successful solutions for hundreds of large-scale electric power projects involving utility/generator paralleling, transfer, peak shaving, and distribution. We pride ourselves in providing electrical power systems that are engineered and custom built, utilizing state-of-the-art technologies to fit our customer's exact needs. The core of our business is low & medium voltage engineered power systems for a wide range of indoor & outdoor applications, such as:

- ⦿ Utility(ies) and Generator(s) Paralleling/Transfer/Peak Shaving/Distribution Switchgear
- ⦿ Microgrids, Microgrid Master Control Panels, SCADA systems
- ⦿ Containerized Battery Energy Storage Systems (BESS)
- ⦿ Photovoltaic (PV) Solar Power Collection/Distribution & Renewable Energy Storage Systems
- ⦿ Low & High Resistance Grounding Systems, Grounding Systems for Photovoltaic Effective Grounding
- ⦿ High Efficiency Combined Heat and Power Switchgear & Control Systems (CHP, Co-generation)
- ⦿ Outdoor Walk-In Electrical Houses (E-Houses) & Skid-Mounted Switchgear
- ⦿ Motor Control Centers & Motor Control Switchgear
- ⦿ Automatic & Manual Load Transfer Switchgear
- ⦿ Bypass/Isolation & Power Distribution Circuit Breaker Switchboards
- ⦿ Generator/Loadbank Quick Connection Switchgear, Switchboards, & Tap Boxes
- ⦿ Industrial Control Panels

Please see our product webpages on www.appt-power.com for product brochures and relevant information. Actual products may look different from images shown on the website and in brochures, based on actual specifications.

APT cares and understands that each power system is different. We will evaluate various solutions in order to develop the best solution for a site. APT focuses on our ability to a combine several traditional pieces of equipment/functionality into as little of a footprint possible. This saves on space, the cost of equipment, cost of installation, and accomplishes the most optimal/state-of-the-art design your facilities. APT's desires to foster and grow a culture of continued open communication with each customer. Let APT be your source to provide fully engineered power system equipment solutions for the full customer facility on time, on or under budget, and in the smallest footprint possible. We are always available to assist customers and engineers representing customers in the development of complex power solutions for all facility types.